

ZEPRO ZS MK2 250 - 170

Installation dimensions (mm)

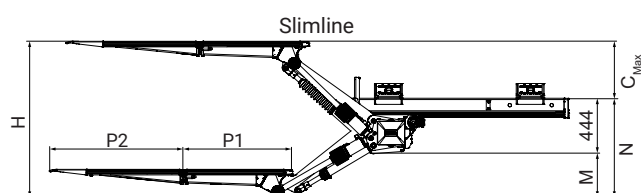

Loading diagram

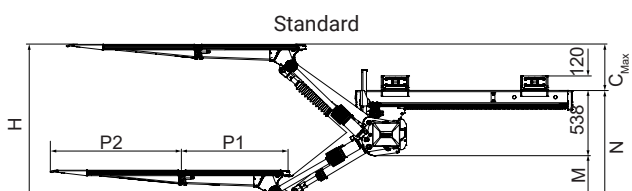
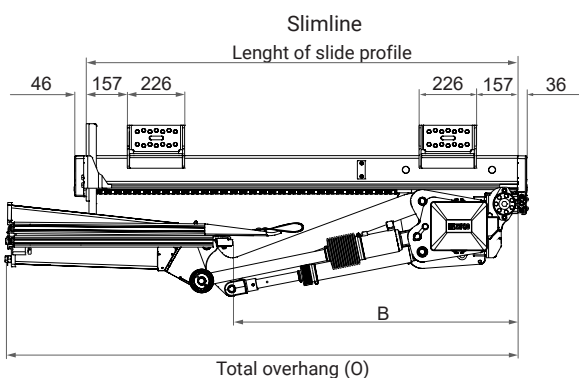
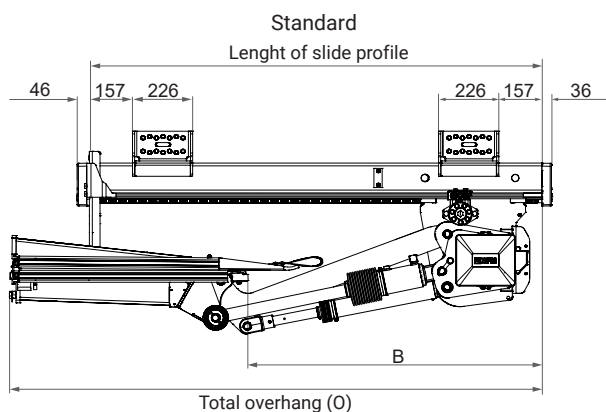
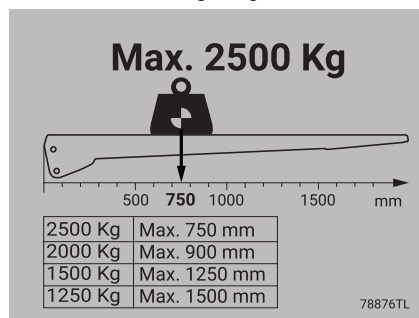

	Lift Height	Slide profile	B	Platform	O
Standard	1700	1850	1229*	1565	1910
				1765	2010
				1965	2110
Slimline	1700	1850	1297*	1565	1977
				1765	2077
				1965	2177

* Valid with 50 mm bavetta. With 70 mm bavetta, the dimension (B) decreases by 20 mm.

	Lift Height	C _{max}	M	N
Standard	1700	580	Max. 513	Max. 1120
Slimline	1700	665	Max. 590	Max. 1034

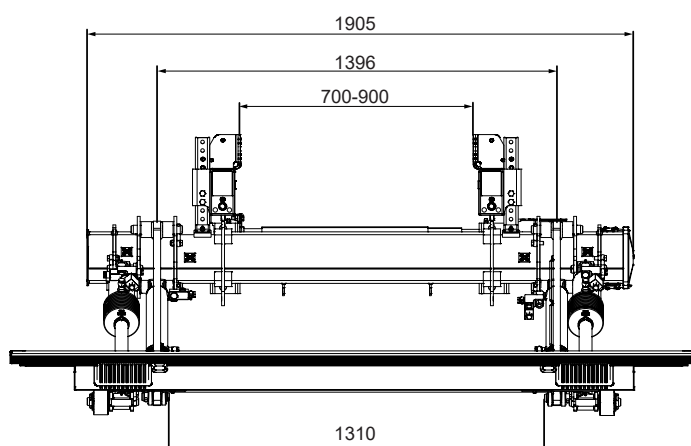

Technical Data Sheet

2023-09-29 | zepro.com

