

ZEPRO ZU 75-110

Loading diagram

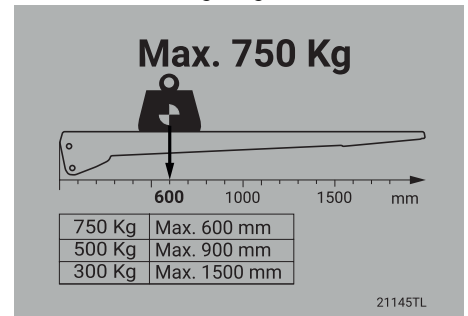

Installation dimensions (mm)

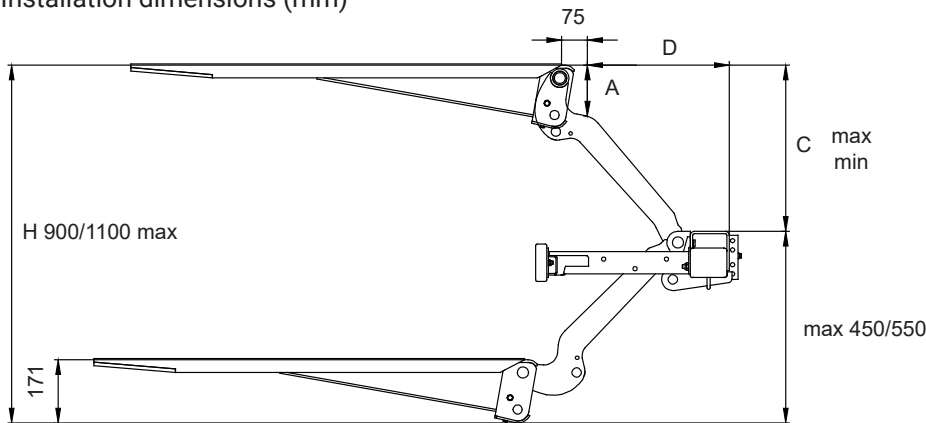

C	A	D	R58:3
550	186	432	Approved
500	168	498	
450	155	549	
400	145	590	
350	137	624	
310	131	652	
250	124	675	

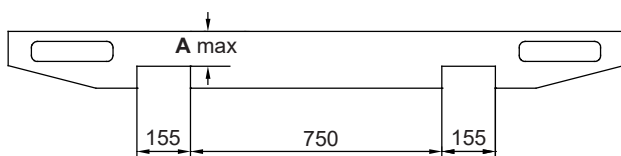
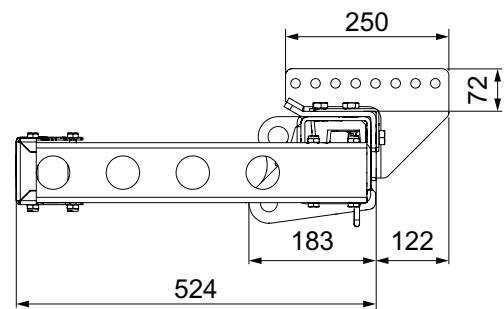
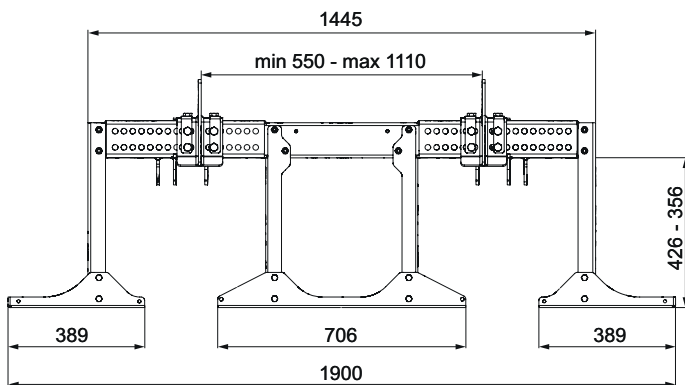

TD-ZEPRO-ZU75-110-EN-EU_230929

Technical Data Sheet

2023-09-29 | zepro.com

