

ZEPRO Z 45-110

Loading diagram

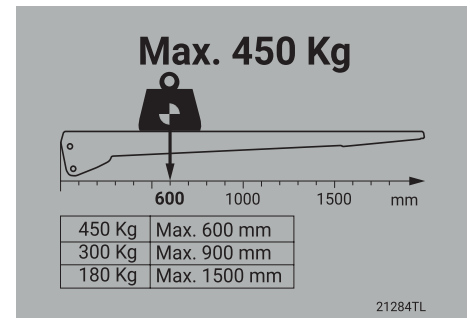

Installation dimensions (mm)

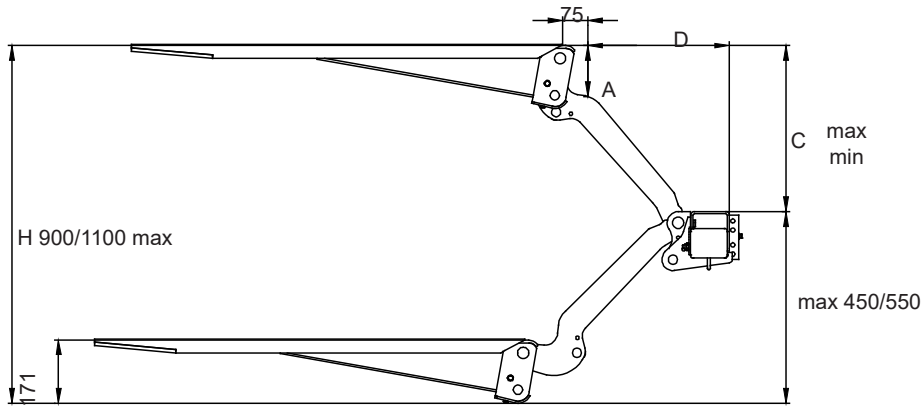

C	A	D
550	186	432
500	168	498
450	155	549
400	145	590
350	137	624
310	131	652
250	124	675

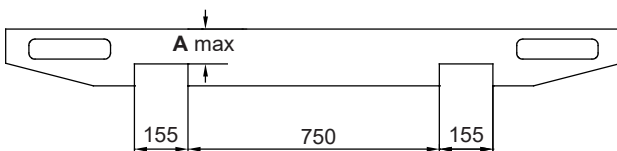
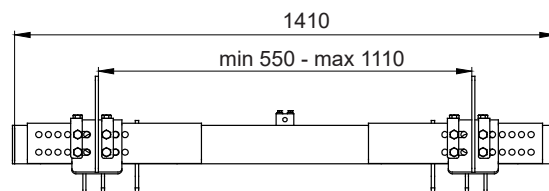
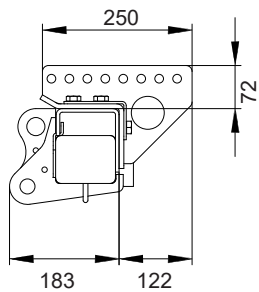

TD-ZEPRO-Z45-110 -EN-EU_230929

Technical Data Sheet

2023-09-29 | zepro.com

