

ZEPRO ZS MK2 150 - 155

Installation dimensions (mm)

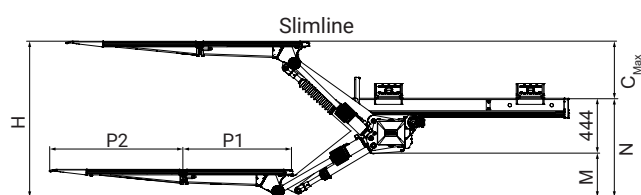

Loading diagram

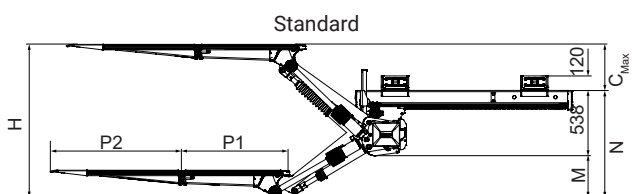
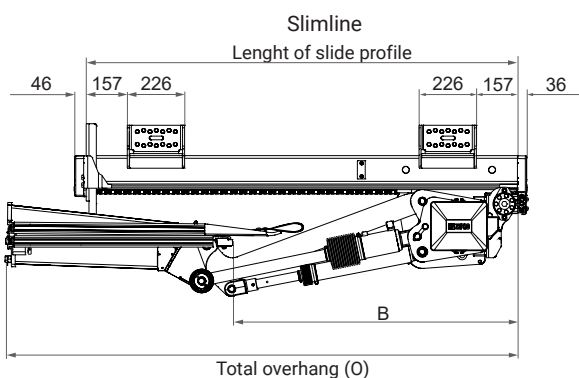
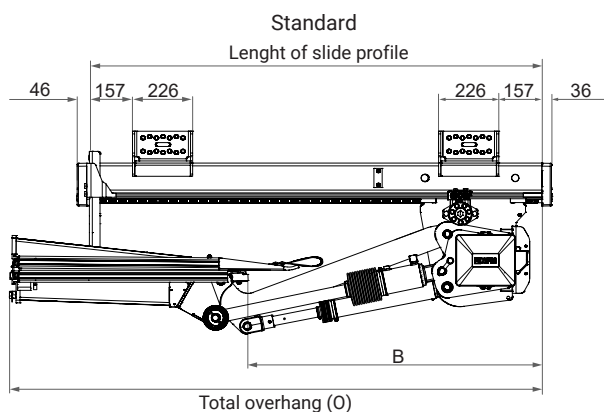
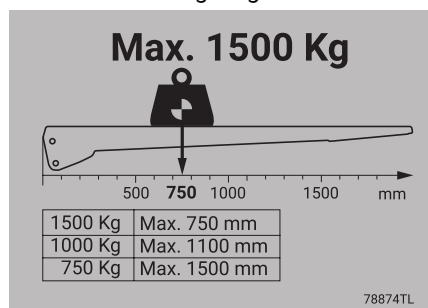

	Lift Height	Slide profile	B	Platform	O
Standard	1510	1700	1109*	1565	1789
				1765	1889
				1965	1989
Slimline	1510	1700	1176*	1565	1856
				1765	1956
				1965	2056

* Valid with 50 mm bavetta. With 70 mm bavetta, the dimension (B) decreases by 20 mm.

	Lift Height	C _{max}	M	N
Standard	1510	490	Max. 486	Max. 1024
Slimline	1510	575	Max. 494	Max. 938

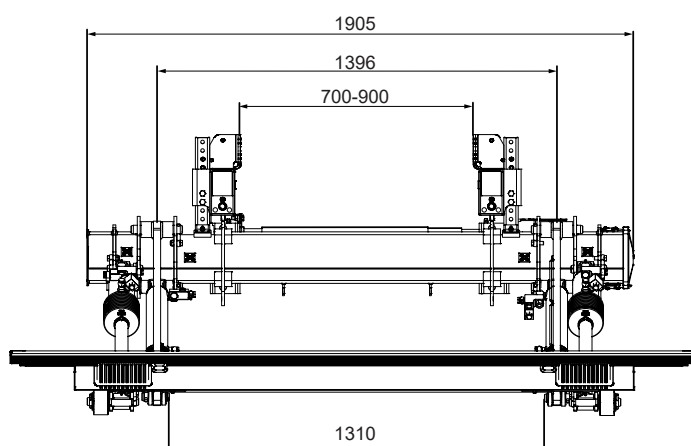

TD-ZEPRO-ZSMK2200-155-EN-EU_20230929

Technical Data Sheet

2023-09-29 | zepro.com

